



BOREA
THE SHADE COMPANY



USER GUIDE

Rayplicker Cobra



Version 1.0 - 11.2022
Ref. UG.RPC.EN.1.0



RAYPLICKER COBRA USER GUIDE

Document version 1.0
Ref. UG.RPC.EN.1.0 / Date 11.2022
Compatible with Rayplicker Cobra spectrophotometer

© Copyright, BOREA SAS.

This document is the property of BOREA SAS and may not be used, reproduced or communicated to third parties without its written authorization.

The most recent version is always available on the site:
www.borea-dental.com

Table of contents

1.	ABOUT THIS USER GUIDE	5
1.1.	Dear customers	5
1.2.	Choice of terms	6
1.3.	Safety instructions	6
1.4.	Symbols description	8
2.	RAYPLICKER SOLUTION DESCRIPTION	9
3.	PACK CONTENT	10
3.1.	Package content	10
3.2.	Spare parts and accessories	11
4.	FIRST START-UP	12
4.1.	Fitting the calibration tip	12
4.2.	Device charging	12
4.3.	Turning on the device	13
5.	DEVICE INTERFACES	13
5.1.	User interface navigation	13
5.2.	Note on device illustrations	14
5.3.	Rayplicker Cobra interfaces tree	14
5.4.	Wifi menu	15
5.5.	Information menu	16
6.	LOCKING AND SHUTTING DOWN THE DEVICE	17
6.1.	Locking the Rayplicker Cobra	17
6.2.	Automatic shutdown of the Rayplicker Cobra	17
6.3.	Turning off the device	17
7.	COLOR TAKING WITH RAYPLICKER COBRA	18
7.1.	Make a shade-taking	18
7.2.	Automatic calibration	19
7.3.	Error messages	20
8.	ACHIEVING A GOOD SHADE TAKING	21
8.1.	Good practices for using the Rayplicker Cobra	21

9.	CLEANING AND DISINFECTION	22
9.1.	General recommendations	22
9.2.	Disinfection and sterilization procedures	23
10.	TECHNICAL SPECIFICATIONS	24
10.1	Identification	24
10.2	AC adapter	24
10.3	Handpiece	24
10.4	Battery	24
10.5	Environmental characteristics	25
10.6	Regulation and standardization	25
10.7	EMC	25
11.	APPENDICES	26
11.1	Glossary	26
11.3	Patents	26
11.4	Warranty	26

1. ABOUT THIS USER GUIDE

1.1. Dear customers

Congratulations on your purchase. The Rayplicker Cobra is a dental shade and translucency device according to known dental art standards with an accuracy of the order of $\Delta E=1$. This self-calibrated device is intended for dentists and prosthetists.

This wireless electro-optical device, made in France, makes it possible to determine exactly the shade of natural teeth and prostheses according to most shade guides used to determine color as well as on the basis of CIE L*a*b* values.

Precise and ergonomic, the Rayplicker Cobra solution is also equipped with a software allowing the processing and recording of data as well as the creation of an order form with ease. The «Pics App Solution» application will allow you to provide patient photos, essential for the proper production of a prosthesis.

In order to achieve perfect shade taking, please read this user guide carefully.

We also invite you to refer to the software user manual mentioned in this document.

Forget the approximate measurements and gain in efficiency and performance with the Rayplicker Cobra.

BOREA team.



1.2. Choice of terms

The terms used in this manual are as follows:

Practitioner, dental surgeon, dental practice = Dentist

Prosthetist, dental prosthesis manufacturing laboratory = Prosthetist

Dentist and prosthetist = Users

1.3. Safety instructions

Warnings

Warning: Avoid electric shock, fire and explosion

- Do not use damaged plugs and chargers or loose electrical outlets.
- Do not touch the charger or the device when your hands are wet and do not pull on the charger to unplug it.
- Do not bend or damage the charger cord.
- Do not cause a short circuit with the charger or the battery pack.
- Avoid contact of the battery pack terminals with metallic objects, as this may cause a short circuit and cause temporary or permanent damage.
- Never use a damaged battery pack.
- Do not drop the charger or battery pack or subject them to shocks.
- Do not charge the device using a charger not approved by BOREA.

Protect the device and charger against damage

Environmental conditions

- Do not store your device in hot or cold places. Do not expose the device to temperatures below 0°C (32°F) or above 40°C (104°F). Extreme temperatures can deform the device and reduce charging capacity and lifespan.
- The device should be stored in a dry place.
- Protect the device from direct sunlight.
- Humidity, steam and all types of liquids can damage the parts or electronic circuits of your device.
- Do not immerse the device or the charger in water or any other liquid.

Falls, Shocks

- Do not drop your device or subject it to impact: your device may malfunction or be damaged and there may be a risk of electric shock.
- Do not place your device on slanted surfaces. If your device falls, it may be damaged.

Radio frequencies, magnetic fields

- Do not use your device near other electronic devices. Most electronic devices use radio frequency signals, interference may cause certain malfunctions.
- Do not store your device near magnetic fields: your device may experience malfunctions (slowness, degraded functions, discharge, etc.)

Precautions for use:

- Do not look directly in the direction of the light source.
- To ensure a clean work environment and patient safety, wear clean surgical gloves when handling the device, such as when changing tips.
- Before each patient, you must disinfect the device and apply a new, previously sterilized tip.
- Please follow the instructions given in the user manual for setting up the sterilizable calibration tip.
- Please follow the cleaning, disinfection and sterilization instructions given in the device user manual.
- When using the device, observe the safety measures applicable to dental practices and dental laboratories.
- The temperature range for measurement should be between 10°C (50°F) and 40°C (104°F).
- Do not use the device if its screen is cracked or broken. Broken glass may injure you. Take your device to a BOREA after-sales service to have it repaired.

Preserve device and charger life

- Do not leave the device or the battery pack alone on charge for more than a week, as overcharging may reduce its lifespan.
- When not in use for an extended period, the device will gradually discharge and must be charged before use.
- When the charger is not in use, do not leave it plugged into a power outlet.

Only use battery packs, chargers, accessories and supplies approved by BOREA.

- Please only use the rechargeable battery packs supplied with the device. The use of other power sources is prohibited and may damage the device.
- Please only use the mains charger supplied with the device by BOREA (5V, 2.4A). Using generic chargers can shorten the life of your device or cause it to malfunction.
- BOREA cannot be held responsible for the user's safety if the user uses accessories or components not approved by BOREA.
- The use of accessories or elements not approved by BOREA voids the warranty.

Do not disassemble, modify or repair your device yourself

- Any repair or maintenance operation must be entrusted to authorized persons. More specifically, access to and replacement of an electronic card can only be carried out by BOREA. Failure to comply with this rule will void the warranty.
- Do not disassemble or puncture the battery pack, as this may cause an explosion or fire.















In case of equipment failure

If at any time the device shows signs of malfunctioning or you suspect that it is not working properly:

- Do not use the device on a patient.
- Unplug the base and make sure it cannot be used before it is serviced (affix a message).
- Contact your dealer or BOREA.

Use your device only for the functions for which it is intended.

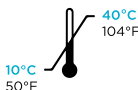
1.4. Symbols description

CEM	Certification mark which indicates that the product complies with the requirements of the German Product Safety Act (ProdSG).	
	The C-UL-US Mark confirms that representative samples of the product have been tested and comply with applicable standards for mechanical, fire, and electric shock hazards for the United States.	
CE	The Rayplicker Cobra device is a Class I medical device. It bears the CE marking in accordance with European Regulation (EU) 2017/745 relating to medical devices. Date of first affixing of CE marking: 2022.	
Elimination	This device and all accessories marked with this symbol must not be disposed of with unsorted household waste. Return of the old device to BOREA SAS.	
Protection class	Protection class II equipment.	
	Read the instructions before use.	
	Serial number	
	Catalogue number	
	Batch number	
	Non-sterile	
	Do not reuse	
	Place of manufacture	
	Operating limit temperatures	
	Recyclable	

2. RAYPLICKER SOLUTION DESCRIPTION

The Rayplicker Cobra is a device intended for the determination of dental color and translucency. It is a multipoint spectral measurement device built around a two-dimensional optical sensor and a spectrometer allowing the acquisition of spectral data at any point of the tooth and the automatic production of a complete and precise cartography of the shade variations of this tooth. The analysis is performed on specific spectral bands relevant for hue recognition. Thanks to its geometry, this wireless device allows access to all the teeth of the mouth.

It has a sterilizable calibration tip allowing it to rest on the patient's teeth, thus ensuring precise positioning of the device.

These tips play an important role because they incorporate a chromatic reference (gray pattern) necessary for the proper functioning of the device through a self-calibration step not perceived by the user.

An oled screen is integrated into the device and displays the analyzed area in real time, thus facilitating the positioning of the measuring head on the tooth. The video stream is also available on the computer screen via the Rayplicker Vision software necessary for the analysis and archiving of data in a patient file. The acquisition is carried out in less than a second and instantly transmitted to the patient file by wifi. Once transmitted, the shade viewer allows you to see a polarized photo, an overall shade map, a three-thirds analysis of the tooth (Cervical, middle, incisal), a 9-zone analysis, a pixel-perfect analysis and an analysis of translucency. The color information is communicated according to the standards of the commonly used shade guides. It is also possible to analyze the color according to the $L^*a^*b^*$ and L^*C^*h standards.

3. PACK CONTENT

3.1. Package content





Articles		Quantity	Reference
Rayplicker Cobra device	1	1	-
Wireless battery pack	2	1	EA0207
Docking station	3	1	SF0210
Dongle	4	1	RA0201
Main charger 5V 2.4A	5	1	EA0211
Documentation: <ul style="list-style-type: none"> • Quick Start Guide • Disinfection and Sterilization Procedures • Best practices for using Rayplicker Cobra • Safety instructions 	6	1	CA0207
Cleaning wipe	7	1	-
Calibration tips x6 (Autoclavable)	8	6	RA0209



3.2. Spare parts and accessories

The following spare parts and accessories are available from BOREA SAS or your distributor.

ACCESSORIES		
	6 Calibration tips (Autoclavable)	Ref : RA0209

SPARE PARTS		
	Main charger 5V 2.4A	Ref : CA0204
	Wireless battery pack	Ref : EA0207
	Docking station	Ref : SF0210
	Dongle	Ref : EA0211

4. FIRST START-UP

4.1. Fitting the calibration tip

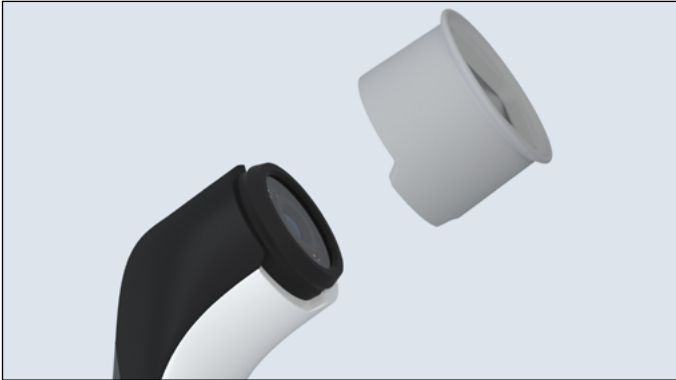

The calibration tip is positioned (clipped) at the end of the measuring head. Thanks to its specific design, it can be supported on the patient's teeth, thus ensuring precise positioning of the device.

It incorporates a chromatic reference (gray pattern) necessary for the proper functioning of the device through a self-calibration step not perceived by the user.

It is necessary to ensure that the calibration tip is clean and in good condition. It must also be protected from the sun's rays and any other type of external aggression. The condition of the tip attests to the quality of the calibration and guarantees the quality of the data collected by the Rayplicker Cobra. We invite you to check the condition of your tips, for this, please refer to the protocol for use of the Rayplicker Cobra present on the BOREA website.

4.2. Device charging

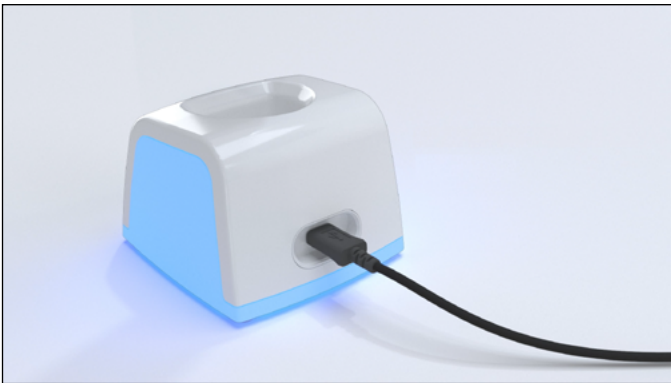

Before its first use, the device must be charged. Charging can take up to 4 hours. To do this, the device must be placed on its base and then connected using the cable to a mains socket.

When the device is charging, the base flashes blue. Once charged, the base turns off.

4.3. Turning on the device



Turn on the device with a long press (2 seconds) on the button on the back of it. An audible signal informs you that it has started correctly.





The device screen lights up and the shade taking icon appears (see «5.3. Rayplicker Cobra interfaces tree», page 14). The strength of the Wifi signal is indicated at the top right of this screen.

5. DEVICE INTERFACES

5.1 User interface navigation

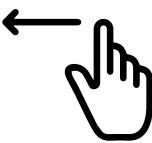
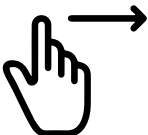
The Rayplicker Cobra device is equipped with an OLED touch screen. To navigate between the different interfaces, follow the instructions below

	<p>A click on the screen enable you to enter the selected menu.</p>
	<p>A swipe to the left scrolls the screens to the left.</p>
	<p>A swipe to the right scrolls the screens to the right.</p>
	<p>A swipe up acts as a return to the previous screen.</p>

5.2. Note on device illustrations

COBRA ICONS					
Scroll left	Scroll right	Back	Device connected but not synchronized	Device connected but not synchronized	Don't move
Transfer in progress	Acquisition validated	Error during Acquisition	Software version	Update failed	Update done
Selected profile	Locked screen	Download			

5.3. Rayplicker Cobra interfaces tree

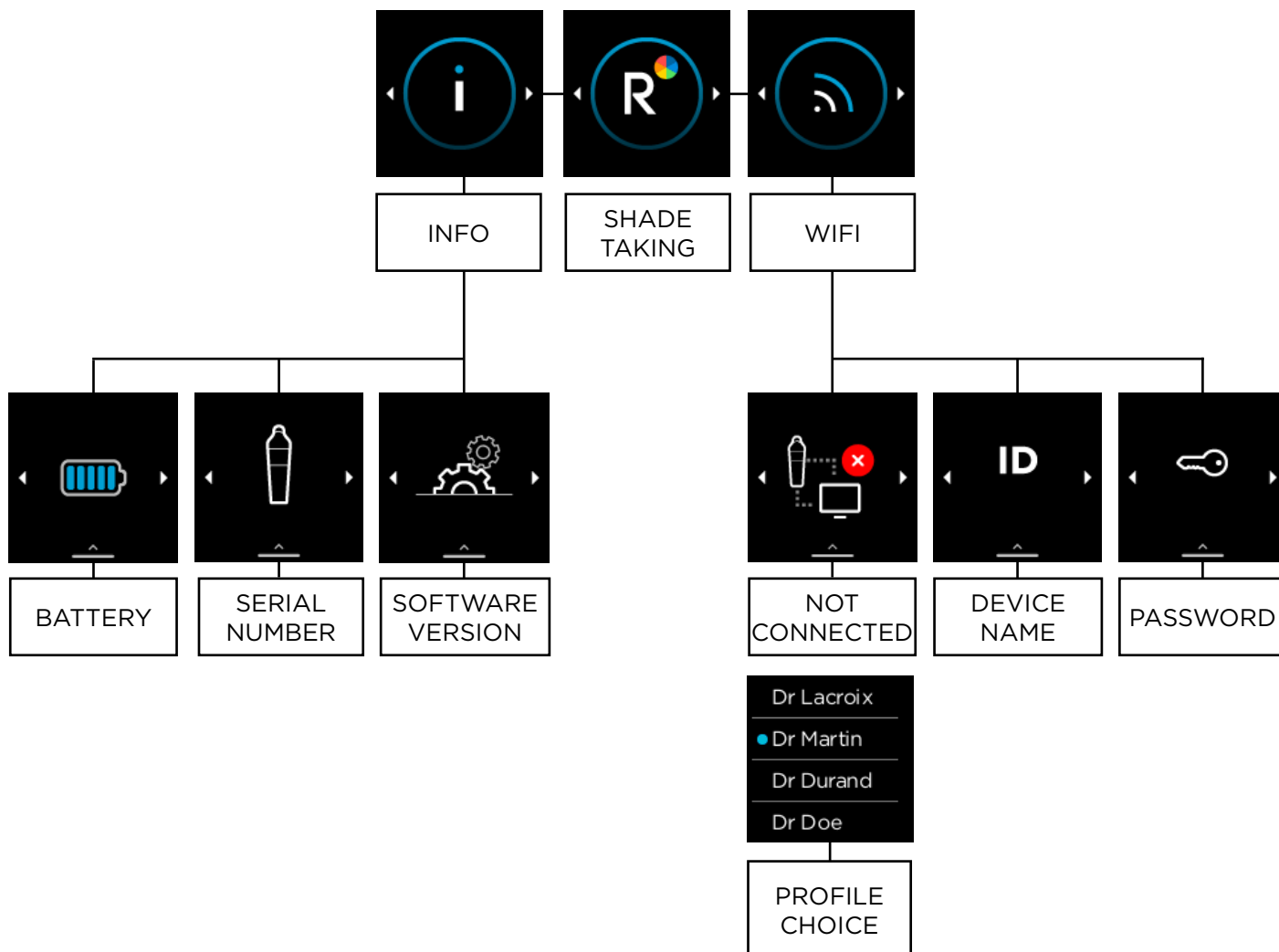

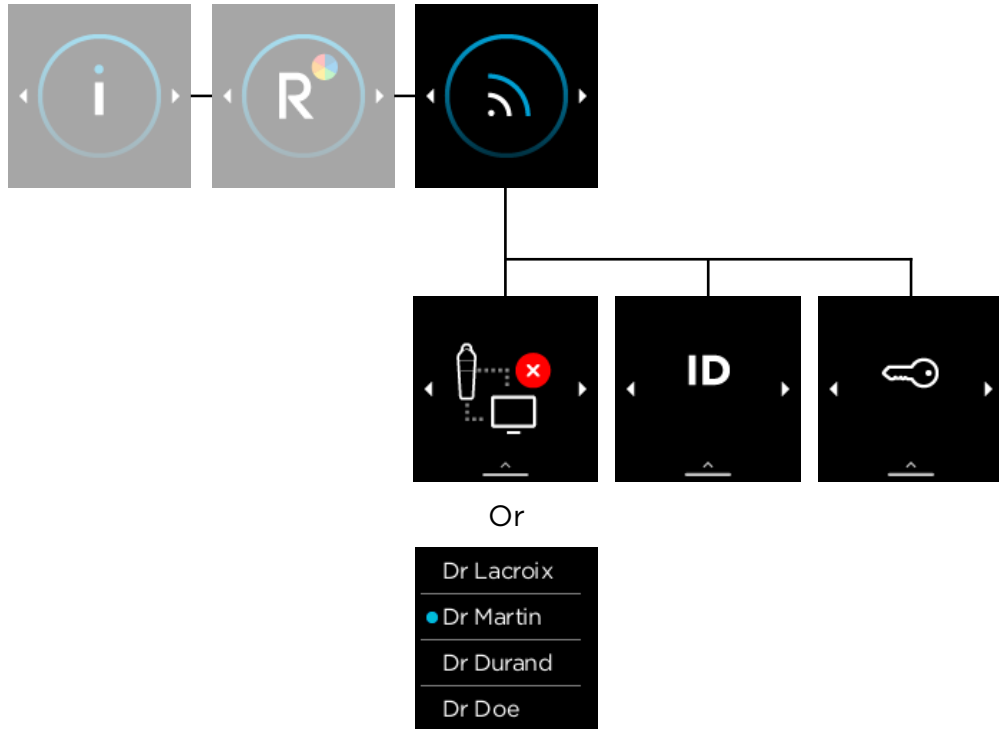

5.4. Wifi menu



To use the Rayplicker Cobra, you must have the Rayplicker Vision software installed on the computer. The software is free to download from www.borea-dental.com.

When the software is installed please follow the on-screen digital quick start guide. In step 5, you must enter the Cobra password indicated in the wifi settings.

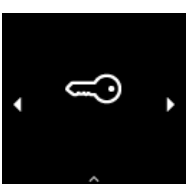
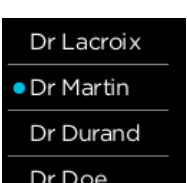
	<p>This interface indicates that the device is not connected to the Rayplicker Vision software.</p>
	<p>This interface only shows the device name. This can be customized from the “Devices” settings in the Rayplicker Vision software.</p>
	<p>This interface indicates the password for connecting the Cobra device to the Rayplicker Vision software. This password can be customized from the “Devices” settings in the Rayplicker Vision software.</p>
	<p>This interface indicates that your device is connected and synchronized with a user profile on Rayplicker Vision software. The connected profile is the one with the blue dot. If you wish to change it, select the profile of your choice from the list on the screen.</p>

5.5. Information menu

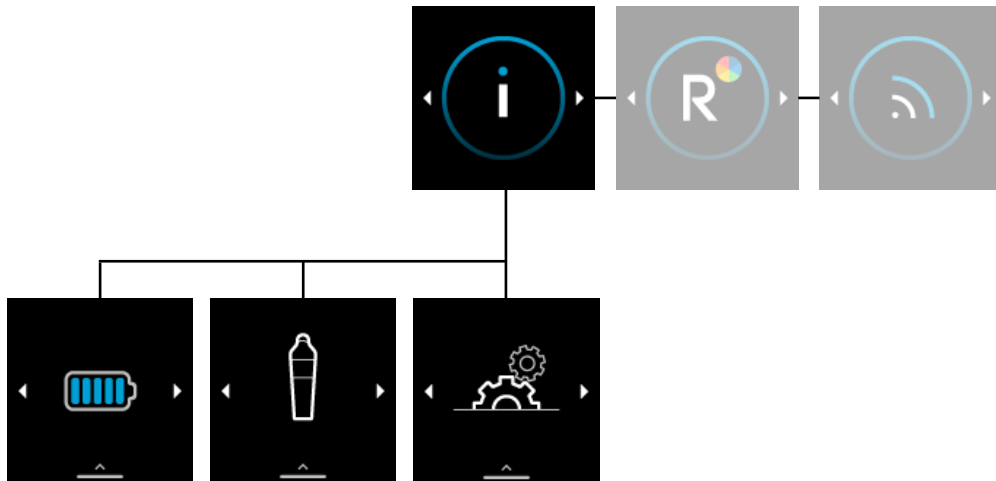

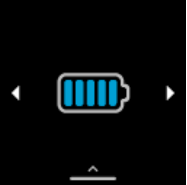
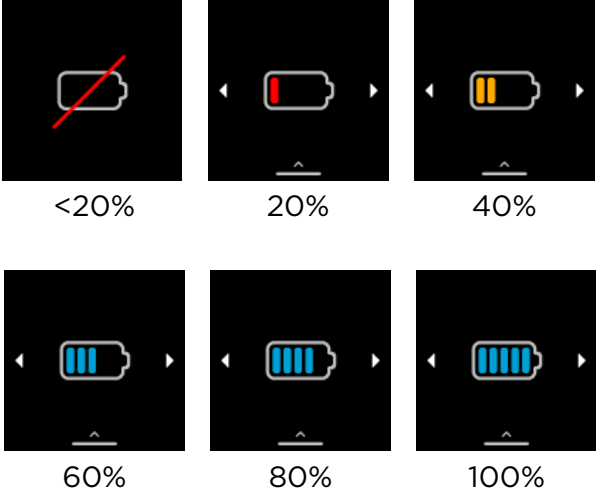
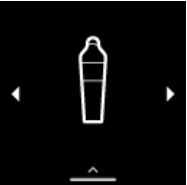
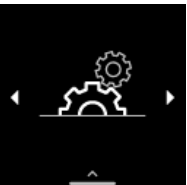
	<p>Here is displayed the battery level of your device.</p> 
	<p>Here is displayed your device serial number.</p>
	<p>Here is displayed your device software version.</p>

6. LOCKING AND SHUTTING DOWN THE DEVICE

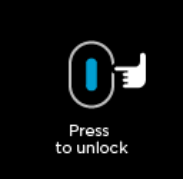

6.1. Locking the Rayplicker Cobra

		<p>Step 1 :</p> <p>By default, after thirty seconds of inactivity, the Cobra locks. If this symbol is displayed, press the trigger to access the device functions again.</p>
---	---	--

6.2. Automatic shutdown of the Rayplicker Cobra





	<p>2nd step :</p> <p>The system automatically shuts down after one minute and 30 seconds of inactivity.</p> <p>These timeframe can be configured in the Rayplicker Vision software in the Devices parameters tab (See Rayplicker Vision manual).</p>
---	--

6.3. Turning off the device

		<p>To turn off your Cobra device without waiting for the automatic shutdown, press and hold the trigger for 2 seconds then press the screen when the “shutdown” symbol appears.</p>
---	---	---

7. COLOR TAKING WITH RAYPLICKER COBRA

7.1. Make a shade-taking

	<p>Open or create the patient file of your choice on the Rayplicker vision software.</p> <p>Make sure your device is connected and synced.</p> <div data-bbox="903 499 1358 577" style="border: 1px solid black; padding: 5px; display: flex; align-items: center; justify-content: space-between;"> ✓ <div style="text-align: center;"> <p>RAYPLICKER COBRA Cobra_EE6A28 Connected and synchronized</p> </div> </div>
	<p>Launch shade taking mode by briefly pressing the trigger, or by pressing the «shade taking» icon</p>
	<p>A video stream is launched to help you position the appliance correctly in contact with the patient's tooth.</p> <p>This video stream is displayed:</p> <ul style="list-style-type: none"> - on the screen of the Cobra device - on the computer screen.
	<p>Briefly press the trigger or click on the touch screen to start the acquisition.</p>

	<p>Take care not to move for 1 second, the time of the spectral acquisition.</p> 
	<p>When the acquisition is complete, the transfer to the patient file is automatic.</p>
	<p>Once the transfer is complete, the shade viewer opens on the Rayplicker Vision software.</p>

7.2. Automatic calibration



The Rayplicker Cobra device performs a self-calibration at each acquisition.

This is done using the sterilizable tip which has a gray pattern. It is necessary to ensure the cleanliness and condition of this calibration tip. It must also be protected from the sun's rays and any other type of external aggression.

The condition of the tip attests to the quality of the calibration and guarantees the quality of the data collected by the Rayplicker Cobra.

We invite you to check the condition of your tips. To do so, please refer to the Good Practices guide presented here [“8.1. Good practices for using the Rayplicker Cobra”](#), page 21, of this manual and on the Borea website www.borea-dental.com.

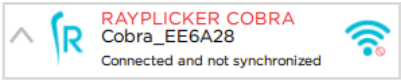
7.3. Error messages

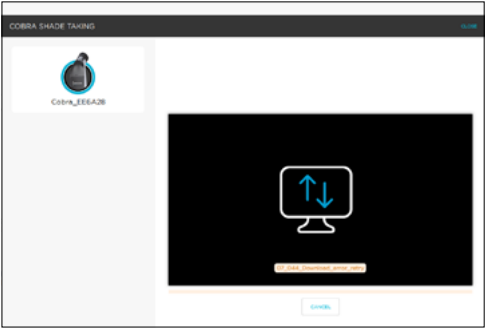
	<p>The device is connected but not synchronized with a user profile on the Rayplicker Vision.</p>  <p>Another Rayplicker Vision software within your structure may be synchronized with the device.</p> <p>To sync to Cobra, go to your device's network settings, then select the profile you want. (See «5.4. Wifi menu», page 15)</p>
	<p>An error occurred during acquisition. Please redo the shade taking.</p>
	<p>An error occurred during the transfer. Click on "CANCEL" to resume a shade.</p>

8. ACHIEVING A GOOD SHADE TAKING

8.1. Good practices for using the Rayplicker Cobra









The specific design of the Rayplicker Cobra measuring head is the result of an ergonomic study which gives it accessibility right up to the pre-molars as well as trouble-free handling thanks to its wireless technology. For optimal shade-taking results, a few good practices listed below should be followed.

BEST PRACTICES FOR USING RAYPLICKER COBRA



- ✓ GREY EDGES PARALLEL TO SCREEN EDGES
- ✓ MOUTH OPENED AND BREATHING THROUGH THE NOSE
- ✓ SALIVA LIMITATION
- ✓ CENTERING THE TOOTH, WITHOUT ANGLE NOR INCLINATION
- ✓ TIP UNDER THE LIP
- ✓ TIP IN CONTACT WITH ADJACENT TEETH
- ✓ TIP IN CONTACT WITH THE GINGIVA
- ✓ DON'T MOVE DURING THE ACQUISITION (1s)

INCORRECT PRACTICES

TIP INCORRECTLY POSITIONED 	MOUTH CLOSED 	CONDENSATION 	EXCESSIVE PRESSURE ON THE GINGIVA 
TOOTH CENTERED INCORRECTLY 	WRONG ANGLE 	WRONG INCLINATION 	VISIBLE LIP 

CALIBRATION TIPS

FAILURE TO RESPECT THE DISINFECTION AND STERILIZATION PROCEDURES CAUSES A HASTY DEGRADATION OF THE TIPS.

A DAMAGED CALIBRATION TIP (DISCOLORATION, MODIFIED ASPECT,...) MUST BE CHANGED.

LIFETIME VERIFIED FOR 100 AUTOCLAVE CYCLE PASSES.



DAMAGED TIP
Internal aspect and/or external shiny and sticky

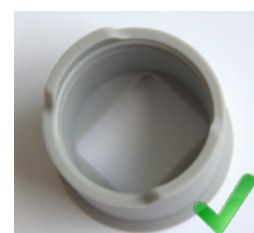

NEW TIP
Internal aspect and external gray and matte

9. CLEANING AND DISINFECTION

9.1. General recommendations

Rayplicker Cobra device:

In order to clean the Rayplicker Cobra, it is recommended to use cleaning and disinfecting wipes for medical devices. Type FD 350 from Durr Dental.

Calibration tips:

The calibration tips (which clip onto the measuring head) are delivered in packs of 6. These must be decontaminated/disinfected and sterilized before use.

- For decontamination/disinfection, it is recommended to use type FD 350 wipes from Durr Dental (contains alcohol) on the interior and exterior parts of the mouthpiece or any other equivalent product. Attention, make sure to respect the manufacturer's specifications:

for wipe type products: type of rinsing, type of drying, drying time, ...

for soaking bath type products: dilution, soaking time, type of rinsing, type of drying, drying time, renewal, ...

- For sterilization: autoclave at 134°C for 20 min (Prion cycle). Lifetime verified for 100 cycles.

WARNING

- If the manufacturer's specifications for the use of the decontamination/disinfection product before going into the autoclave are not respected, degradation of the tip may be observed. It is then necessary to change the tip.
- The sterilisable tip has a lifespan validated for 100 autoclave sterilization cycles. Beyond the recommended sterilization quota, the tip may be damaged and discoloration of the gray pattern may appear. It is then necessary to change the tip.





DAMAGED TIP
Internal aspect and/or
external shiny and sticky





NEW TIP
Internal aspect and
external gray and matte

9.2. Disinfection and sterilization procedures

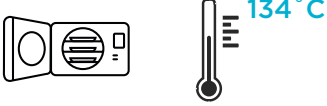
Please follow the steps below:

STEPS	CALIBRATION TIPS	RAYPLICKER DEVICE
<p>- 1 - DISINFECTION</p>	<p>AUTHORIZED WIPES (⚠)</p> 	
<p>- 2 - RINSING</p>	<p>RINSE THOROUGHLY WITH WATER</p> 	
<p>- 3 - STERILIZATION</p>	<p>AUTOClave STERILIZATION</p> 	



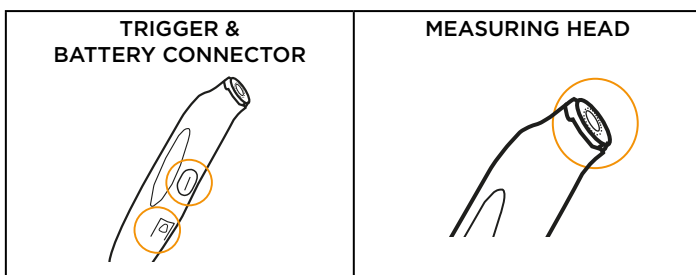

 Disinfectant wipes for surfaces of non-invasive medical devices with bactericidal, fungicidal, virucidal and tuberculocidal properties.

 Please follow the manufacturer's instructions (contact time required). See below for risk areas. This device disinfection protocol is mandatory after each use to avoid cross-contamination.

RISKY AREAS IN CASE OF EXCESSIVE USE OF DISINFECTANTS



NON-COMPLIANT PRODUCTS AND PROCESSES

<p>HEAVY-SOAKED WIPES</p> 	<p>SPRAYABLE SOLUTION</p> 	<p>DECONTAMINATION BATH</p> 	<p>ULTRASOUND BATH</p> 
---	---	--	--

10. TECHNICAL SPECIFICATIONS

10.1 Identification

Manufacturer	BOREA SAS
Medical device name	Rayplicker Cobra

10.2 AC adapter

Manufacturer	HN Electronic Components Gmbh & Co. KG
Model	HNP12-MicroUSBL6
Supply voltage	100-240V AC
Power frequency	50/60 Hz
Output voltage	5.0V DC
Output current	2.4 A

10.3 Handpiece

Weight (g)	155
Dimensions (mm)	L. 185 x l. 40 x H. 30
Sensor	CMOS 648 x 648 px
Spectrophotometer	Measuring range : 400-700 nm
Measuring head dimensions (mm)	L. 76 x Ø. 25
Screen	OLED Color touch screen
Resolution	128 x 128 NTSC
Docking station weight (g)	120
Docking station dimensions (mm)	L. 70 x l. 65 x H. 55

10.4 Battery

Type	Lithium-ion
Capacity	1600 mAh / 3.7 V
Lifetime	5 years

10.5 Environmental characteristics

Operating temperature	+10°C à +40°C
Operating relative humidity	30% to 75%
Operating atmospheric pressure	800 hPa à 1060 hPa
Maximum Operating Altitude	< 2000m
Storage temperature	0°C to +40°C
Storage relative humidity	10% à 95%, condensation included
Storage atmospheric pressure	500 hPa à 1060 hPa

10.6 Regulation and standardization

The Rayplicker Cobra device is a Class I medical device. It bears the CE marking in accordance with European Regulation (EU) 2017/745 relating to medical devices. Date of first CE marking: 2022.

The unique identifier FR022935_05DXTJ attesting to registration in the register of producers in the EEE sector, pursuant to article L.541-10-13 of the Environmental Code, has been assigned by ADEME to the company BOREA (SIRET: 79353699600036). This identifier certifies its conformity with regard to its obligation to register in the register of producers of Electrical and Electronic Equipment and the realization of its declarations of placing on the market with ecosystem.

10.7 EMC

The use of the Rayplicker Cobra device at the same time or in close proximity to another electronic device should be avoided as this could affect its proper functioning. If this use cannot be avoided, check that both devices are functioning normally.

The use of accessories and cables other than those specified or supplied by the manufacturer of the Rayplicker Cobra may cause an increase in electromagnetic emissions or a decrease in its electromagnetic resistance and thus cause it to malfunction.

Portable radio communications equipment, cellular telephones, portable wifi access points or other similar systems should be used no closer than 30cm to the Rayplicker Cobra device, including cables specified by the manufacturer. If these conditions are not met, the performance of the Rayplicker device may be degraded.

The user can therefore take preventive measures, such as changing the location of the device or orienting it differently.

Regarding electromagnetic compatibility, Rayplicker Cobra complies with the IEC60601-1-2 standard

11. APPENDICES

11.1 Glossary

Spectrophotometer :

Device allowing the acquisition of spectral data at any point of the tooth. These wavelengths are analyzed and then compared to a database in order to deduce the color of a tooth.

Shade:

It characterizes the dominant wavelength of light reflected by a tooth. It is the shade that gives this sensation of color (red, yellow, green or blue...).

Translucency:

Characteristic of a material that allows light rays to pass and undergoes scattering. You can see through translucent material but you cannot distinguish shapes.

11.3 Patents

The Rayplicker Cobra is protected by the following patents:

France:

1556140; 1556141; 1651452

US:

14837,449

11.4 Warranty

The guarantees are specified in the general conditions of sale.

These can be viewed on the website www.borea-dental.com in the download tab.